

ADDENDUM

Addendum No.: C1588M

Date: May 5, 2005

Manuals Affected: **KBD300A Universal Keyboard – C527M-L**
KBD4000 Genex Multiplexer Keyboard - C1921M-G

Manual Update: ECO 05-10910 optimizes joystick performance whenever you power up the KBD300A and KBD4000. It also provides an automatic calibration mode.

Automatic Calibration of the Joystick

The KBD300A and KBD4000 will calibrate the joystick automatically on power-up and every 30 minutes of inactivity. This is the default operation of the keyboard and will ensure optimal joystick performance. Make sure the joystick remains in the center position as power is applied to the keyboard. Do not move or hold down the joystick until after the red LEDs have finished flashing the software version number.

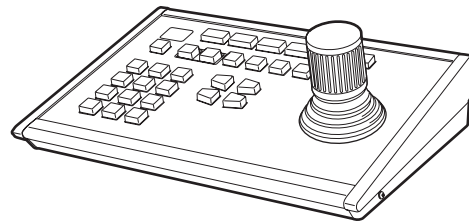

**KBD4000
Genex® Multiplexer
Keyboard**

**Installation/
Operation Manual**

C1921M-G (1/04)







Pelco World Headquarters • 3500 Pelco Way, Clovis, CA 93612-5699 USA • www.pelco.com

USA & Canada: Tel: 800/289-9100 • Fax: 800/289-9150

International: Tel: 1-559/292-1981 • Fax: 1-559/348-1120

CONTENTS

Section	Page
IMPORTANT SAFEGUARDS AND WARNINGS	4
REGULATORY NOTICES	4
DESCRIPTION	5
INSTALLATION	6
MODES OF OPERATION	6
DO A MULTIPLEXER MODE INSTALLATION	6
DO A MULTIPLEXER SERVER MODE INSTALLATION	8
CHECK THESE THINGS	9
MULTIPLEXER	9
MULTIPLEXER SERVER	9
SETTING COAXITRON CONTROL OF CAMERAS	10
WHAT'S NEXT?	10
PROGRAMMING	11
CONTROLLING THE MULTIPLEXER WITH THE KEYBOARD	11
PASSWORD	11
MENUS	12
SYSTEM SETUP (VIEW KEY)	13
ADVANCED SYSTEM SETUP (VIEW KEY)	15
RECORD SETUP (LIVE/VCR KEY)	18
CUSTOM VCR SETUP (LIVE/VCR KEY)	20
CAMERA SETUP (NUMBER AND CAM KEYS)	21
ACTIVITY DETECTION MASK SETUP	23
SEQUENCE SETUP (SEQ KEY)	24
HELP MENU	25
ALARM LOG	25
MULTIPLE CAMERA DISPLAY SETUP	26
PROGRAMMING THE PICTURE-IN-PICTURE DISPLAY 	26
PROGRAMMING THE 4-CAMERA DISPLAY 	26
PROGRAMMING THE 9-CAMERA DISPLAY 	27
PROGRAMMING THE 16-CAMERA DISPLAY 	27
PROGRAMMING MENU DEFAULTS	28
PROGRAMMING A PRESET	29
PROGRAMMING A PATTERN	29
OPERATION	30
TROUBLESHOOTING	38
SPECIFICATIONS	39
INDEX	40
WARRANTY AND RETURN INFORMATION	42

LIST OF ILLUSTRATIONS

Figure	Page
1 Connecting Keyboard to Multiplexer	6
2 Connecting Keyboards to the Server	8
3 Multiplexer Front Panel	11
4 Menu Tree	12
5 Basic System Setup Menu	13
6 Advanced System Setup Menu	15
7 Basic VCR Setting Menu	18
8 Custom VCR Setup Menu	20
9 Basic Camera Menu	21
10 Activity Detection Mask	23
11 Camera Sequencing Menu	25
12 Help Menu	25
13 KBD4000 Keyboard Definitions	30

LIST OF TABLES

Table	Page
A Camera Numbers with Switch 7 ON	7
B Keyboard Addresses	8
C VCR Types	19
D Programming Menu Defaults	28
E Operation Guide	31

IMPORTANT SAFEGUARDS AND WARNINGS

Prior to installation and use of this product, the following WARNINGS should be observed.

1. Installation and servicing should only be done by qualified service personnel and conform to all local codes.
2. Unless the unit is specifically marked as a NEMA Type 3, 3R, 3S, 4, 4X, 6 or 6P enclosure, it is designed for indoor use only and it must not be installed where exposed to rain and moisture.
3. Only use replacement parts recommended by Pelco.
4. After replacement/repair of this unit's electrical components, conduct a resistance measurement between line and exposed parts to verify the exposed parts have not been connected to line circuitry.

REGULATORY NOTICES

This equipment has been tested and found to comply with the limits of a Class B digital device, pursuant to part 15 of the FCC rules. These limits are designed to provide reasonable protection against harmful interference in a residential installation. This equipment generates, uses, and can radiate radio frequency energy and, if not installed and used in accordance with the instructions, may cause harmful interference to radio communications. However there is no guarantee that the interference will not occur in a particular installation. If this equipment does cause harmful interference to radio or television reception, which can be determined by turning the equipment off and on, the user is encouraged to try and correct the interference by one or more of the following measures:

- Reorient or relocate the receiving antenna.
- Increase the separation between the equipment and the receiver.
- Connect the equipment into an outlet on a circuit different from that to which the receiver is connected.
- Consult the dealer or an experienced radio/TV technician for help.

DESCRIPTION



The KBD4000 Genex® Multiplexer Keyboard is a full-function keyboard controller for the MX4000 Genex Multiplexer and MX4000SVR Genex Multiplexer Server.

This manual covers the KBD4000 keyboard's operation with both duplex and simplex models of the multiplexer. The differences, as they pertain to the keyboard, are indicated as necessary.

The mode of operation depends on whether the keyboard is connected to a multiplexer or to a server. (See *Modes of Operation* for an explanation.)

In addition to performing all the control functions that can be done from the multiplexer's front panel, the keyboard features a three-axis joystick and additional keys to control fixed and variable speed pan, tilt, and lens functions. The keyboard can also operate presets, auxiliaries, and patterns and can be used to program the multiplexer or server.

IMPORTANT DIFFERENCES IN SIMPLEX AND DUPLEX MULTIPLEXER OPERATING MODES.

The **simplex** multiplexer has three operating modes:

- Live** The main monitor can show live video both in full-screen or multi-screen views. You cannot record in live mode. The multiplexer's DISPLAY/RECORD LED is off.
- VCR** The main monitor shows full-screen or multi-screen views of videotape playback. You cannot record in VCR mode. The multiplexer's DISPLAY/RECORD LED is off.
- Record** The main monitor shows live video of an individual camera in full-screen view only. You can record only when in record mode. While recording, all cameras are being recorded simultaneously. The multiplexer's DISPLAY/RECORD LED is on.

The **duplex** multiplexer has two operating modes:

- Live** The main monitor shows live video both in full-screen or multi-screen views. You can record while viewing any or all cameras. While recording, all cameras are being recorded simultaneously. The multiplexer's LIVE/VCR LED is on.
- VCR** The main monitor shows full-screen or multi-screen views of videotape playback. You can record in VCR mode if you have a second VCR connected to the VCR OUT jack on the multiplexer. The multiplexer's LIVE/VCR LED is off.

INSTALLATION

The following parts are supplied:

- 1 KBD4000 keyboard
- 1 25-foot (7.6 m) data cable

1 MODES OF OPERATION

The mode of operation depends on whether the keyboard is connected to a multiplexer or to a server.

Multiplexer Mode A single keyboard is plugged into the back of a Genex MX4000 Multiplexer.

Multiplexer Server Mode Up to four keyboards can be connected to the back of a Genex MX4000SVR Multiplexer Server. Each keyboard connected to the remote keyboard port requires a KBDKIT(-X).

Proceed to the *Do A Multiplexer Mode Installation* section (step 1A) or *Do A Multiplexer Server Mode Installation* section (step 1B).

1A DO A MULTIPLEXER MODE INSTALLATION

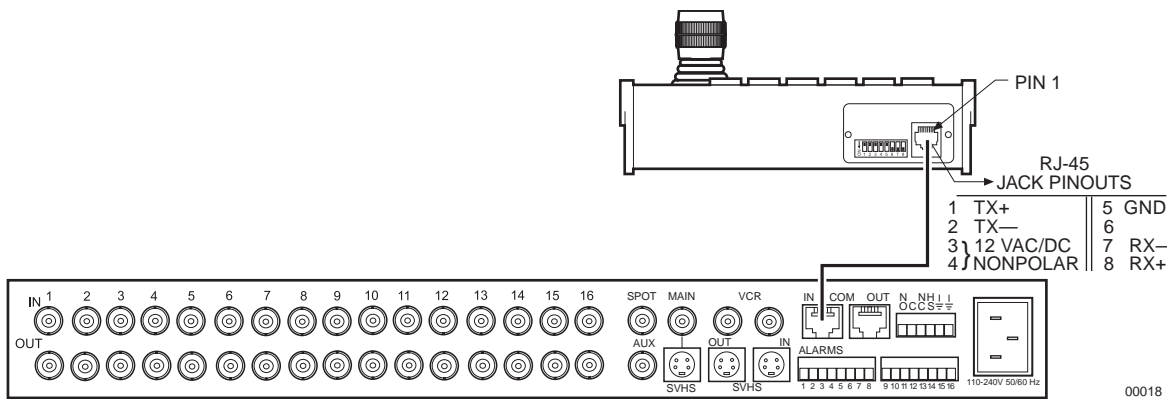

Figure 1. Connecting Keyboard to Multiplexer

1. Remove the DIP switch cover plate from the rear of the keyboard (refer to Figure 1).
2. Set the switches (refer to Figure 1 for switch locations).

ADDRESS

Set switches 1, 2, and 3 OFF. This is address 0, which selects the multiplexer operating mode.

COMMUNICATION MODE

- Set switch 4 OFF to enable polled communication mode. Use this for normal keyboard operation.
- Set switch 4 ON to put the keyboard in non-polled communication mode. Use this when the keyboard communicates remotely over communications media that do not support polled mode. These are any communications media that introduce significant delay in transmitting data (for example, phone line transmission systems). In non-polled mode, the keyboard can control multiplexers only. The multiplexer server does not support non-polled mode.

UNUSED

Leave switch 5 OFF. It is not used.

TURBO MODE

Set switch 6 ON to enable the turbo (extra fast) pan feature or OFF to disable.

CAMERA ADDRESS MODE

There are two modes for addressing cameras:

- Set switch 7 ON if you want to address all cameras consecutively from 1-256 (refer to Table A).
- Set switch 7 OFF if you want to address cameras in groups of 16 according to the multiplexer to which they are connected. For example, multiplexer 1, cameras 1-16; multiplexer 2, cameras 1-16, etc.

Table A. Camera Numbers with Switch 7 ON

Multiplexer	Cameras	
	9-channel	16-channel
1	1-9	1-16
2	17-25	17-32
3	33-41	33-48
4	49-57	49-64
5	65-73	65-80
6	81-89	81-96
7	97-105	97-112
8	113-121	113-128
9	129-137	129-144
10	145-153	145-160
11	161-169	161-176
12	177-185	177-192
13	193-201	193-208
14	209-217	209-224
15	225-233	225-240
16	241-249	241-256

PROGRAMMING MODE

Set switch 8 ON to program the multiplexer and camera presets and patterns from the keyboard. Set to OFF to disable programming.

3. Replace the cover on the back of the keyboard.
4. The keyboard comes with a 25-foot (7.6 m) data cable with RJ-45 connectors. Plug one end into the back of the keyboard and the other end into the COM IN connector on the back of the multiplexer. Refer to Figure 1.

The keyboard receives power from the multiplexer. **The LED display lights momentarily when the keyboard receives power and stays on when you enter a multiplexer address.**

The KBD4000 has calibrating software for automatically centering the joystick. Be certain the joystick remains in the neutral (vertical) position as power is applied to the keyboard. Do not move or hold down the joystick until after the red digit LEDs have finished flashing the firmware revision.

5. Peel off the protective covering over the LED display in the keyboard's upper left corner.

NOTE: For distances over 25 feet (7.6 m), you **must** order the KBDKIT(-X) Remote Keyboard Wiring Kit. Refer to the KBDKIT(-X) manual for installation procedures.

1B DO A MULTIPLEXER SERVER MODE INSTALLATION

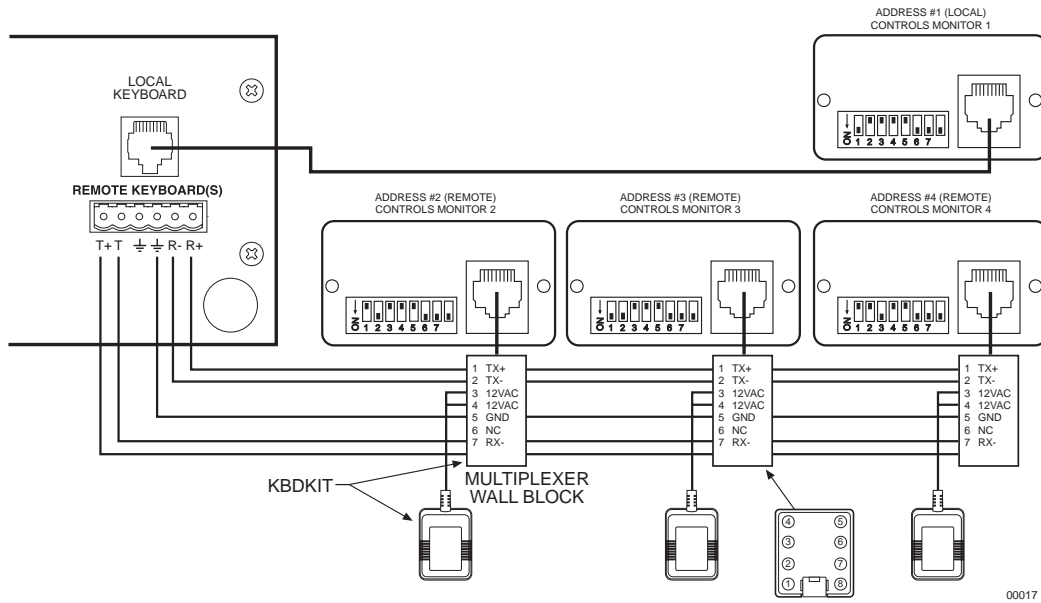

Figure 2. Connecting Keyboards to the Server

If the keyboard will be connected to a server that will operate in paired mode configuration, only addresses 1 and 3 can be used. Refer to the server manual for information about paired mode configuration.

1. Remove the DIP switch cover plate from the rear of the keyboard (refer to Figure 1).
2. Set the switches (refer to Figure 1 for switch locations).

ADDRESS

Set the keyboard address according to Table B.

Table B. Keyboard Addresses

Keyboard Address	Switch Settings		
	1	2	3
1	ON	OFF	OFF
2	OFF	ON	OFF
3	ON	ON	OFF
4	OFF	OFF	ON

UNUSED

Switches 4 and 5 **must** be set OFF. They are not used in multiplexer server mode.

TURBO MODE

Set switch 6 ON to enable the turbo (extra fast) pan feature or OFF to disable.

CAMERA ADDRESS MODE

There are two modes for addressing cameras:

- Set switch 7 ON if you want to address all cameras consecutively from 1-256 (refer to Table A).
- Set switch 7 OFF if you want to address cameras in groups of 16 according to the multiplexer to which they are connected. For example, multiplexer 1, cameras 1-16; multiplexer 2, cameras 1-16, etc.

PROGRAMMING MODE

Set switch 8 ON to program the multiplexer and server and OFF to disable programming.

3. Replace the cover on the back of the keyboard.
4. Connect the keyboard to the MX4000SVR Multiplexer Server.

You can connect up to four keyboards to the server—one to the server's LOCAL KEYBOARD port and three to its REMOTE KEYBOARD(S) port, or all four to the remote.

LOCAL KEYBOARD PORT CONNECTION

Plug one end of the 25-foot (7.6 m) data cable with RJ-45 connectors supplied with the keyboard into the back of the keyboard. Plug the other end into the LOCAL KEYBOARD port on the server. Refer to the multiplexer server manual for instructions.

The keyboard receives power from the multiplexer, as indicated by a lighted LED display. The display shows the address of the multiplexer with which the keyboard is communicating.

REMOTE KEYBOARD(S) PORT CONNECTION

You must order a KBDKIT(-X) for each keyboard you intend to connect to the server's REMOTE KEYBOARD(S) port. Follow the instructions supplied with the kit. Refer to Figure 1 for the keyboard RJ-45 pin-outs.

The keyboard receives power from the transformer, as indicated by a lighted LED display. The display shows the address of the multiplexer with which the keyboard is communicating.

The KBD4000 has calibrating software for automatically centering the joystick. Be certain the joystick remains in the neutral (vertical) position as power is applied to the keyboard. Do not move or hold down the joystick until after the red digit LEDs have finished flashing the firmware revision.

5. Peel off the protective covering over the LED display in the keyboard's upper left corner.

2 CHECK THESE THINGS

IMPORTANT: *The keyboard is ready to operate when plugged into a multiplexer or multiplexer server. However, some minimal programming may be required to make your system work. Do not assume there is nothing more to do after connecting the keyboard to the system.*

2A MULTIPLEXER

Below are the minimum things to check.

1. If you have more than one multiplexer, each one must have its own address (UNIT ID in the Advanced System Setup menu). If you have a server, the multiplexer address must match the input on the server to which it is connected. For example, if the multiplexer is connected to input 3 on the server, set the multiplexer address to 3.
2. Set the master/slave designation to let the keyboard communicate with multiplexers.
 - In **polled** mode (switch 4 OFF), you must designate one multiplexer (any one) as the master and all the others as slaves. If you have just one multiplexer, it must be the master.
 - In **non-polled** communication mode (switch 4 ON), all multiplexers must be slaves (the keyboard is the master).

Set the address and master/slave designation from the front panel of the multiplexer, not from the keyboard. For instructions, refer to *Controlling the Multiplexer with the Keyboard* in the *Programming* section.

2B MULTIPLEXER SERVER

Below is the minimum you should check.

If you intend to control two monitors from one keyboard (paired mode), you must change the settings for the monitors (Monitor menu). Programming the server **can only** be done from the keyboard. Refer to the server manual for instructions.

3 SETTING COAXITRON® CONTROL OF CAMERAS

NOTE: *If you have a multiplexer server, you must enter the Camera menu from the multiplexer's front panel. Then you can program the cameras from the front panel of the multiplexer or from the keyboard.*

The KBD4000 keyboard provides Coaxitron control of pan, tilt, and lens functions. There are three Coaxitron format settings, which are set in the *Camera Setup* section.

Standard	Use for moveable cameras controlled by 15-bit standard Coaxitron receivers, such as the CX9000 Series, the PT7700, and the ED25/27/28/29. The KBD4000 keyboard, in conjunction with a Genex multiplexer, supports all pan, tilt, and lens functions, and auxiliary on/off. The keyboard does not set or call presets or support preset scanning.
Extended (Default)	Use for moveable cameras controlled by 32-bit extended Coaxitron receivers, such as Esprit®, Intercept®, Spectra®, and the LRD41C21/LRD41C22 Series. The KBD4000 keyboard, in conjunction with a Genex multiplexer, supports all 15-bit functions, plus the setting and calling of presets and patterns. A different control, such as the MPT9500, is required to program labels for presets and patterns.
Off	Use for fixed cameras.

4 WHAT'S NEXT?

At this point you can work through the *Programming* section or proceed directly to the *Operating* section.

PROGRAMMING

NOTE: To program a multiplexer if a multiplexer server is installed, you **must** enter programming mode from the multiplexer's front panel. After doing so, you can program the multiplexer through its front panel or you can navigate and make programming selections through the keyboard.

This section applies only to programming the multiplexer. The multiplexer can be programmed from the keyboard or from the multiplexer's front panel. To program the multiplexer from the front panel, refer to the multiplexer manual. To program the multiplexer server, refer to the server manual.

Programming lets you configure the multiplexer (from the KBD4000) for the way you want your system to operate. The multiplexer automatically selects the most common operating parameters. However, some minimal programming may be required to make your system work.

Programming of system, camera, and VCR setup; camera sequencing; and alarm and activity detection is done through on-screen menus displayed on the main monitor. You can enable a password to prevent unauthorized access to the menus.

Programming of the picture-in-picture, and 4-, 9-, and 16-camera displays can be done directly without going through menus. (Refer to the *Multiple Camera Display Setup* section.)

CONTROLLING THE MULTIPLEXER WITH THE KEYBOARD

IMPORTANT INSTRUCTIONS

Before you can use the keyboard to control the multiplexer(s), do the following **at the front panel of the multiplexer(s)**.

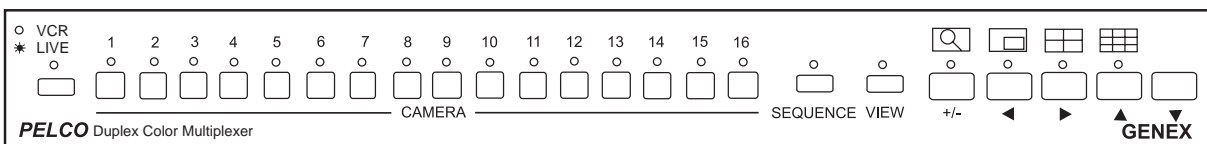

Figure 3. Multiplexer Front Panel

IMPORTANT: The Genex multiplexer lets you work in any of four languages: English (default), French, German, or Spanish. If you need to change the language, do so before programming because you must reset the multiplexer to factory defaults **before** you can change the language. See the *MX4000 Genex Series Simplex and Duplex Multiplexers Installation/Operation Manual* for details.

1. Press the VIEW button for about three seconds. The basic System Setup menu appears and the currently selected menu item blinks.
2. Use the arrow buttons to highlight ADVANCED SETUP.
3. Press the +/- button. The Advanced System Setup menu appears. Skip steps 4 and 5 if your system has only one multiplexer.
4. Use the arrow buttons to move the cursor to UNIT ID.
5. Press the +/- button to select the multiplexer's UNIT ID.
6. Use the arrow buttons to move the cursor to COMM TYPE.
 - In **polled** communication mode (switch 4 off), one multiplexer must be the master and all others slaves.
 - In **non-polled** mode (switch 4 on), all multiplexers must be slaves (the keyboard is master).
7. Use the arrow buttons to go to EXIT. Press the +/- button to exit the menu. You can now use the keyboard to program the multiplexer(s).

PASSWORD

You can program the multiplexer to request a password for access to programming menus. Refer to the *Advanced System Setup* section for information on enabling the password.

The universal password is 3916 and cannot be changed. You must enter this password whenever the system requests one. Enter it from the keyboard by pressing each number followed by the CAM key (3, CAM, 9, CAM, 1, CAM, 6, CAM).

MENUS

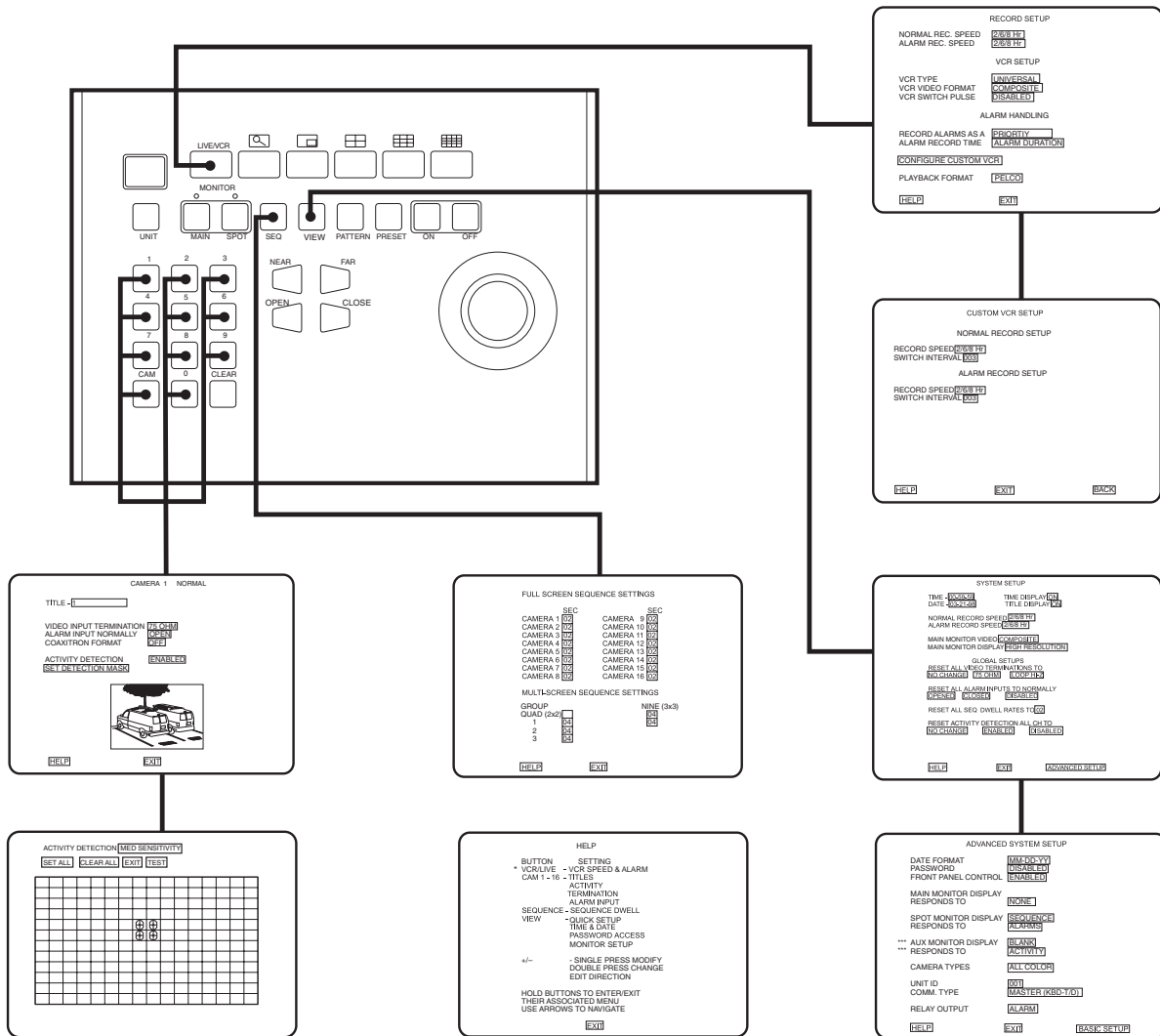

NOTE: Refer to the procedures for larger views of the menus.

01473

Figure 4. Menu Tree

TIP: Once in a menu, you can access another by pressing that menu's key(s).

TIP: In any menu you can scroll the options forward with the OPEN key and backward with the CLOSE key.

Press and hold the VIEW key to switch to the System Setup menu.

Enter a camera number and then press and hold the CAM key to change to the Camera menu.

Press and hold the SEQ key to switch to the Sequence menu.

Press and hold the LIVE/VCR key to switch to the Record Setup menu.

You must be in main monitor mode to program from the keyboard. Press the MAIN MONITOR key.

To exit the menus, select EXIT and then press the OPEN or CLOSE key.

SYSTEM SETUP (VIEW KEY)

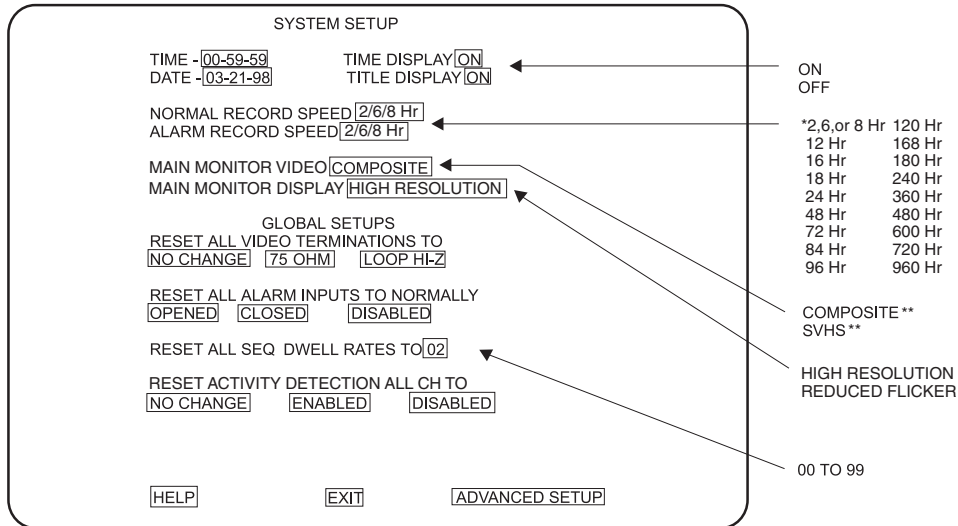

* 2/6/8 HR FOR NTSC/EIA MODEL MULTIPLEXERS, 3 HR FOR PAL/CCIR MODELS.
 REMAINING RECORD SPEEDS DEPEND UPON VCR MODEL.
 ** NOT SHOWN ON DUPLEX MONOCHROME MODELS OR SIMPLEX MULTIPLEXERS

Figure 5. Basic System Setup Menu

To program the main basic system parameters:

1. Press the MAIN MONITOR key.
2. Use the number pad to enter the address of the multiplexer (1-16 if the keyboard is connected to a multiplexer; 1-8 if the keyboard is connected to a server), and then press the UNIT key.
3. Press the VIEW key for about three seconds.
4. Type the password (3916), if requested. Enter it by pressing each number key followed each time by the CAM key. The System Setup menu appears. The currently selected menu item blinks.
5. Use the joystick to move among items on the screen. When the menu item you desire is highlighted (blinking), do one of the following:
 - If a menu item has more than one option, press the OPEN key to cycle through the options to select the one you want.
 - If a menu item has only one option, press the OPEN key to select it.

Time and Date

Set the current time and date. The time uses a 24-hour clock.

Time Display

ON – Displays the time on the main monitor.
 OFF – The time is not shown on the main monitor.

Title Display (Duplex Multiplexer)

ON – Displays camera titles and the word LIVE or VCR on the main monitor.
 OFF - Camera titles and the word LIVE or VCR are not shown on the main monitor.

Title Display (Simplex Multiplexer)

ON – Displays camera titles on the main monitor.
 OFF - Camera titles are not shown on the main monitor.

NOTE: Title Display shows 12 characters maximum in all modes except 16-camera display, in which only 9 characters are shown.

Record Speeds

Sets the speed at which the VCR normally records video and at which it records when there is an alarm(s). Setting the speeds in the System Setup menu also sets the speeds in the Record Setup and Custom VCR Setup menus.

Main Monitor Video (Duplex Color Models Only)

COMPOSITE is standard video on coaxial cable. SVHS is higher resolution video on a special cable.

Main Monitor Display

The options are HIGH RESOLUTION and REDUCED FLICKER. Select REDUCED FLICKER when there is flickering on the monitor screen, such as from a neon light. This problem is more visible to the eye in PAL-format multiplexers.

GLOBAL SETUPS

Video Terminations

These settings set the terminations for **all** video inputs. To set individual inputs, refer to the *Camera Setup* section.

- Set to 75 OHM when equipment is connected **only** to the video IN connectors. There must be no equipment connected to the video OUT connectors.
- Set to LOOP HI-Z when equipment is connected to the video OUT (looping) connectors. For every channel that has equipment connected to the video IN connector, there **must** be equipment connected to the video OUT. **Do not** use this global setting if any channel has equipment connected to a video input but **no** equipment connected to the video output. Equipment connected to the looping connectors must be terminated at 75 ohms.
- NO CHANGE – This is a pass-through selection in case you unintentionally hit the OPEN key. This is not an undo key. This will not change settings.

Alarm Inputs

- Normally closed operation = current flow = alarm switch or relay closed
- Normally open operation = current flow = alarm switch or relay open

Dwell Rates

Sets the sequence dwell rate for **all** cameras. To set individual dwell rates for cameras, refer to the *Sequence Setup* section.

Activity Detection

- ENABLED/DISABLED – Turns activity detection on or off for **all** video inputs. To set individual inputs, refer to the *Camera Setup* section.
- NO CHANGE – This is a pass-through selection in case you unintentionally hit the OPEN key. This is not an undo key. This will not change settings.

6. When you finish all the changes you want to make, go to EXIT or ADVANCED SETUP.
7. Press the OPEN key to exit programming mode or go to the Advanced System Setup menu.

When HELP is highlighted, you can press the OPEN key to display a help screen that tells you which keys to press to configure specific options.

ADVANCED SYSTEM SETUP (VIEW KEY)

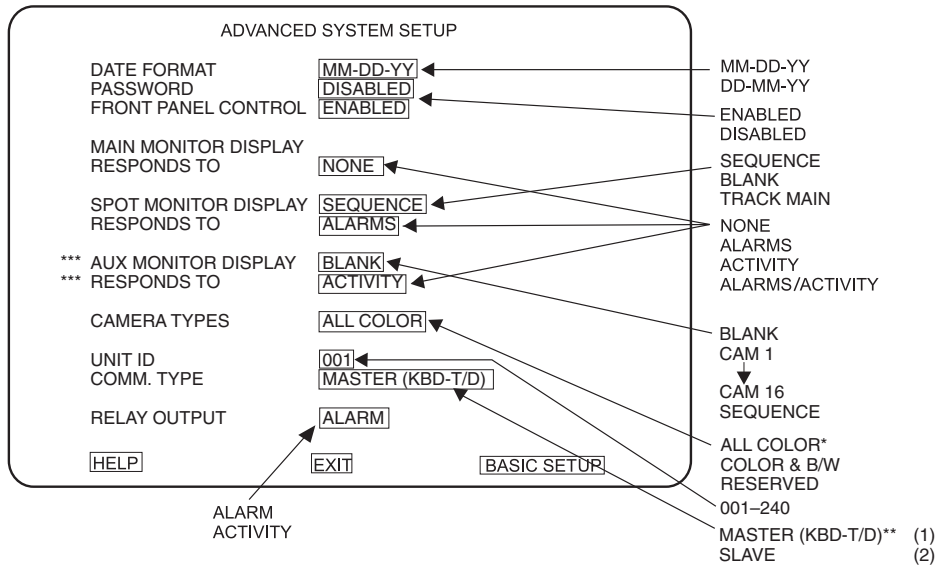

* ALL B/W SHOWN ON MONOCHROME MODELS.

** MUST BE SET IN THIS MODE FROM THE FRONT PANEL OF THE MULTIPLEXER TO PROGRAM THE MULTIPLEXER FROM THE KEYBOARD.

*** DUPLEX MULTIPLEXER ONLY; NOT ON SIMPLEX

(1) SIMPLEX DEFAULT SETTING

(2) DUPLEX DEFAULT SETTING

Figure 6. Advanced System Setup Menu

To program the advanced main system parameters:

1. Press the MAIN MONITOR key.
2. Use the number pad to enter the address of the multiplexer (1-16 if the keyboard is connected to a multiplexer; 1-8 if the keyboard is connected to a server), and then press the UNIT key.
3. Press the VIEW key for about three seconds. The basic System Setup menu appears. The currently selected menu item blinks.
4. Use the joystick to highlight ADVANCED SETUP.
5. Press the OPEN key. The Advanced System Setup menu appears.
6. Use the joystick to move among items on the screen. When the menu item you desire is highlighted (blinking), press the OPEN key to cycle through the options.

Date Format

Sets the format for displaying the date on the main monitor.

Password

Enables or disables password control to access programming menus.

Front Panel Control

Enables or disables the front panel buttons to operate the multiplexer. In either mode you can access programming menus. It has no effect on the keyboard.

Main Monitor Display

- Select ALARMS, ACTIVITY, or ALARMS/ACTIVITY if you want the main monitor to switch to cameras that have alarms or activity detection.
- Select NONE if you are using the main monitor for normal video and you do not want alarms or activity detection to override what you are watching.

Spot Monitor Display

- Select BLANK, SEQUENCE, or TRACK MAIN if you want the spot monitor to switch to cameras that have alarms or activity detection. Then under RESPONDS TO, select ALARMS, ACTIVITY, or ALARMS/ACTIVITY.
- Select NONE if you are using the spot for normal video and you do not want alarms or activity detection to override what you are watching.

The options are defined as follows:

- BLANK – Lets you view an individual camera, but you cannot run a sequence. An alarm or activity detection will override the camera you are watching. When the alarm or activity detection goes away, the screen returns to the camera you were watching.
- SEQUENCE – Lets you view an individual camera or run a sequence. An alarm or activity detection will override the camera you are watching. When the alarm or activity detection goes away, the screen returns to the camera you were watching.
- TRACK MAIN – The spot monitor will follow the camera switching that occurs on the main monitor. This feature is used only when a KBD4000 keyboard is connected to the multiplexer for controlling moveable cameras. This mode provides an easy way of simplifying PTZ control in single-monitor applications. The operator does not have to switch to SPOT to gain PTZ control and there is no separate control of the spot monitor when in this mode.

Aux Monitor Display (Duplex Multiplexer Only)

- Select ALARMS, ACTIVITY, or ALARMS/ACTIVITY if you want the auxiliary monitor to show cameras that have alarms or activity detection.
- Select NONE if you are using the auxiliary monitor to sequence through all cameras and you do not want alarms or activity detection to override the sequence.

The options are defined as follows:

- BLANK – This means the screen remains blank unless there is an alarm or activity detection.
- SEQUENCE – This means the monitor sequences all cameras unless there is an alarm or activity detection.
- CAM 1 through CAM 16 – This means the monitor displays the selected camera unless there is an alarm or activity detection.

Camera Types

- COLOR & B/W – This setting lets the multiplexer adapt to the combination of both color and monochrome video signals. The multiplexer's switching speed is slower when it must change formats between monochrome and color cameras.

For **duplex** monochrome models, you will not receive color from a color camera except on the SPOT or AUX monitor displays.

For **simplex** monochrome models, you will not receive color from a color camera except in RECORD mode.

- RESERVED – This setting can improve performance when using cameras with non-standard sync or poor video quality.

Unit ID

This is the multiplexer's address. If your system has more than one multiplexer, each must have its own address. This must be set at the multiplexer—not at the keyboard.

NOTE: *When programming the MX4000 multiplexer from the KBD4000 keyboard, DO NOT TRY TO CHANGE THE UNIT ID. Changing the unit ID from the keyboard interrupts keyboard communication to the multiplexer, causing erratic multiplexer operation. Refer to the Troubleshooting section to correct the situation.*

Comm. Type

- In **polled** communication mode (switch 4 off), one multiplexer (any one) must be the master. Only one multiplexer can be master; all others must be slaves. The master multiplexer communicates with the slave multiplexers.
- In **non-polled** communication mode (switch 4 on), all multiplexers must be slaves (the keyboard is master).

The default is MASTER for duplex models and MASTER (KBD T/D) for simplex models.

Relay Output

This operates the relay on the back of the multiplexer. The relay is used to change the VCR to its alarm recording speed.

- In alarm mode, an alarm signal is produced when a remote switch opens or closes a ground in the multiplexer (for example, if a switch is on a door and the door is opened).
- In activity mode, the multiplexer continually monitors select camera inputs for motion. When motion is detected, the multiplexer increases the frequency with which that camera(s) is shown and recorded. Activity detection is most effective when only a few cameras are showing activity (refer to the *Camera Setup* section).

7. When you finish all the changes you want to make, go to EXIT or BASIC SETUP.
8. Press the OPEN key to exit programming mode or go to the basic System Setup menu.

When HELP is highlighted, you can press the OPEN key to display a help screen that tells you which keys to press to configure specific options.

RECORD SETUP (LIVE/VCR KEY)

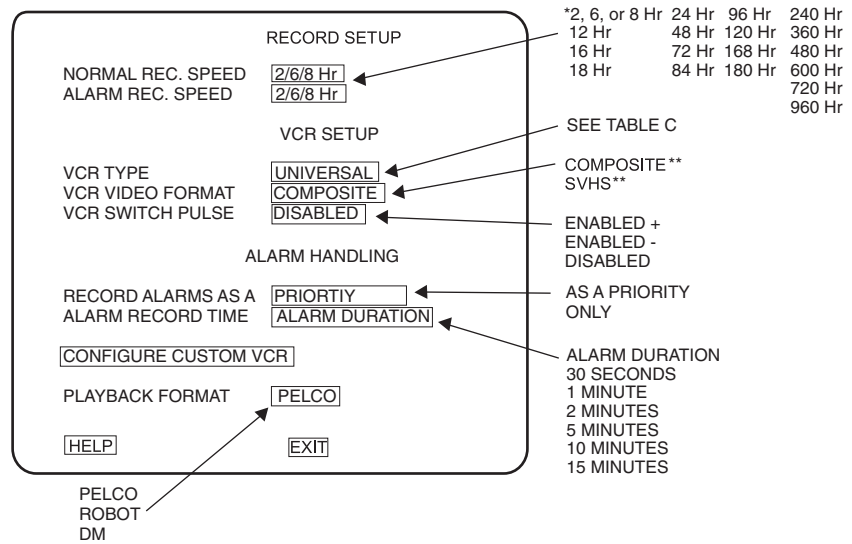

* 2/6/8 HR FOR NTSC/EIA MODEL MULTIPLEXERS, 3 HOUR FOR PAL/CCIR MODELS.
REMAINING RECORD SPEEDS DEPEND UPON VCR MODEL.
** NOT SHOWN ON MONOCHROME MODELS.

Figure 7. Basic VCR Setting Menu

To program the VCR recording parameters:

1. Press the MAIN MONITOR key.
2. Use the number pad to enter the address of the multiplexer (1-16 if the keyboard is connected to a multiplexer; 1-8 if the keyboard is connected to a server), and then press the UNIT key.
3. Press the LIVE/VCR button for about three seconds.
4. Type the password (3916), if requested. Enter it by pressing each number key followed each time by the CAM key. The Record Setup menu appears. The currently selected menu item blinks.
5. Press the OPEN key to cycle through the options to select the one you want.

Record Speeds

Sets the speed at which the VCR normally records video and at which it records when there is an alarm(s). Setting the speeds in the System Setup menu also sets the speeds in the Record Setup and Custom VCR Setup menu.

VCR Type (See Table C)

If your VCR is not listed among the options, do either of the following:

- Select UNIVERSAL. In the recording speed menu item at the top of the screen, select an option your VCR will support.
- Select CUSTOM. Then go to CONFIGURE CUSTOM VCR and press the OPEN key to go to the Custom VCR Setup menu. The switch interval can be changed only while in this setting.

VCR Video Format

This feature is not available on monochrome multiplexers. COMPOSITE is standard video on a coaxial cable. SVHS is higher resolution video on a special cable.

VCR Switch Pulse

- ENABLED + means the multiplexer waits for a **positive** head switching pulse from the VCR. If the multiplexer does not get a pulse from the VCR (because of a broken wire or the VCR does not give a pulse in some modes), it may appear the multiplexer is not working properly.
- ENABLED – (minus sign) means the multiplexer waits for a **negative** head switching pulse from the VCR.
- DISABLED means the VCR head switching pulse is not used.

Alarm Handling

This determines how alarms are recorded and for how long.

Configure Custom VCR

Press the OPEN key to access the CUSTOM VCR SETUP menu.

Playback Format

You can play tapes made using Pelco, Robot, and DM multiplexers.

6. When HELP is highlighted, you can press the OPEN key to display a help screen that tells you which keys to press to configure specific options.
7. Press the OPEN key to exit the programming mode.

Table C. VCR Types

NTSC	PAL
UNIVERSAL	UNIVERSAL
GYR TLC1800	ASUTA TLVCR 251
GYR 2100	ASUTSA TLVCR 964
GYR 2100 HD MODE	BURLE TC3910X
JVC SR-L900U	HITACHI VTL30E
JVC SR-L901U	HITACHI VT-L1000E
JVC SR-9070U	HITACHI VT-L2000E
JVC BR-S925U	JVC BR9060E
mitsubishi HS7424U	JVC BR-S920/925
mitsubishi HS7496U	JVC SR-L900E
mitsubishi HS5168U	MITS. HS5300/5600
MITS. HS7168U NORM	MITS. HS5424E
MITS. HS7168U HD	PANAS. AG6024/6124
PANASONIC AG-RT600	PANASONIC AG6720
PANASONIC AG6124	PANASONIC AG6730
PANASONIC AG 6730	PANASONIC AG6040
PELCO TLR2024	SANYO TLS900P
PELCO TLR2096	SANYO TLS1000
PELCO TLR2168 NORM	SANYO SRT-500P
PELCO TLR2168HD	SANYO TLS2000
SANYO SRT600	SONY SVT100P
SANYO TLS924/972	SONY SVT5000P
SANYO TLS2500/7000	CUSTOM
TOSHIBA KV6300	
TOSHIBA KV7024A	
TOSHIBA KV7168A	
TOSHIBA KV7960A	
TOSHIBA KV8168A	
CUSTOM	

CUSTOM VCR SETUP (LIVE/VCR KEY)

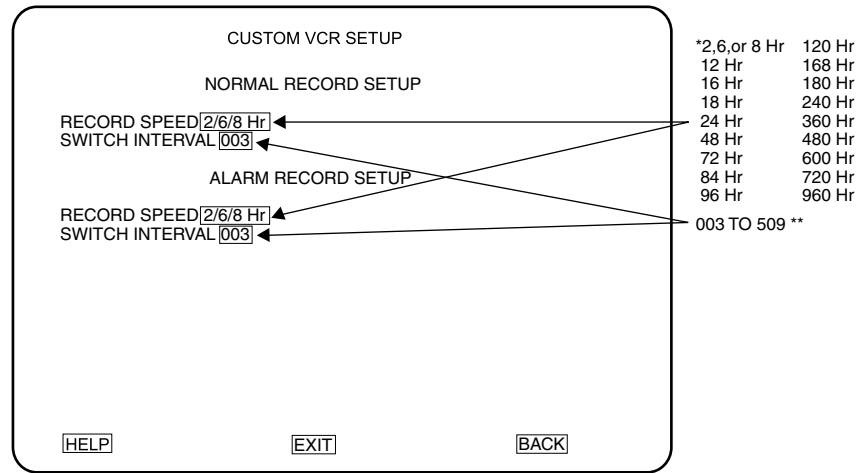

*2/6/8 HR FOR NTSC/EIA MODEL MULTIPLEXERS, 3 HR FOR PAL/CCIR MODELS.
REMAINING RECORD SPEEDS DEPEND UPON VCR MODEL.
** VCR TYPE IN RECORD SETUP MENU MUST BE SET TO CUSTOM IN ORDER TO
MAKE SELECTIONS.

Figure 8. Custom VCR Setup Menu

NOTE: For proper recording, the switching rate of the multiplexer must match that of the VCR. If they do not match, the VCR may skip frames or record duplicate frames.

To program the advanced VCR parameters:

1. Press the MAIN MONITOR key.
2. Use the number pad to enter the multiplexer's address (1-16 if the keyboard is connected to a multiplexer; 1-8 if the keyboard is connected to a server), and then press the UNIT key.
3. Press the LIVE/VCR button for about three seconds. The Record Setup menu appears and the currently selected menu item blinks.
4. Ensure VCR TYPE in the Record Setup menu is set to CUSTOM.
5. Use the joystick to highlight CONFIGURE CUSTOM VCR.
6. Press the OPEN key. The Custom VCR Setup menu appears.
7. Use the joystick to move between items on the screen. When the menu item you desire is highlighted (blinking), press the OPEN key to cycle through the options.

Record Speeds

Sets the speed at which the VCR normally records video and at which it records when there is an alarm(s). Setting the speeds in the Custom VCR Setup menu also sets the speeds in the System Setup and Record Setup menus.

Interval

Interval is the number of fields the VCR records before switching to the next camera.

8. When you finish all the changes you want to make, go to EXIT or BACK.
9. Press the OPEN key to exit programming mode or return to the Record Setup menu.

When HELP is highlighted, you can press the OPEN key to display a help screen that tells you which keys to press to configure specific options.

(If you play back the tape on the same equipment, any covert picture will still appear blanked. Change the setting to NORMAL to see the picture.)

Video Termination

- Set to 75 OHM when equipment is connected to the video IN connector only.
- Set to LOOP HI-Z when equipment is also connected to the video OUT (looping) connector. Equipment connected to the looping connector must be terminated at 75 ohms.

Alarm Input

- Normally closed operation = current flow = alarm switch or relay closed
- Normally open operation = current flow = alarm switch or relay open

Coaxitron Format

- EXTENDED – Use when your system has moveable cameras controlled by 32-bit Coaxitron receivers, such as Esprit, Intercept, Spectra, and the LRD41C21/LRD41C22 Series.
- OFF – Use when your system has fixed cameras only.
- STANDARD – Use when your system has moveable cameras controlled by 15-bit Coaxitron receivers, such as the CX9000 Series, the PT7700, and the ED25/27/28/29.

Activity Detection

A camera can be set to respond or not respond to activity. If enabled, select SET DETECTION MASK to define what part of the camera's viewing field will be monitored for activity.

5. To program another camera, press the number key for that camera, and then press the CAM key. Repeat steps 2-4.
6. When you finish all the changes you want to make, go to EXIT.
7. Press the OPEN key to exit programming mode.

When HELP is highlighted, you can press the OPEN key to display a help screen that tells you which keys to press to configure specific options.

NOTE: *The Coaxitron format default setting is EXTENDED.*

ACTIVITY DETECTION MASK SETUP

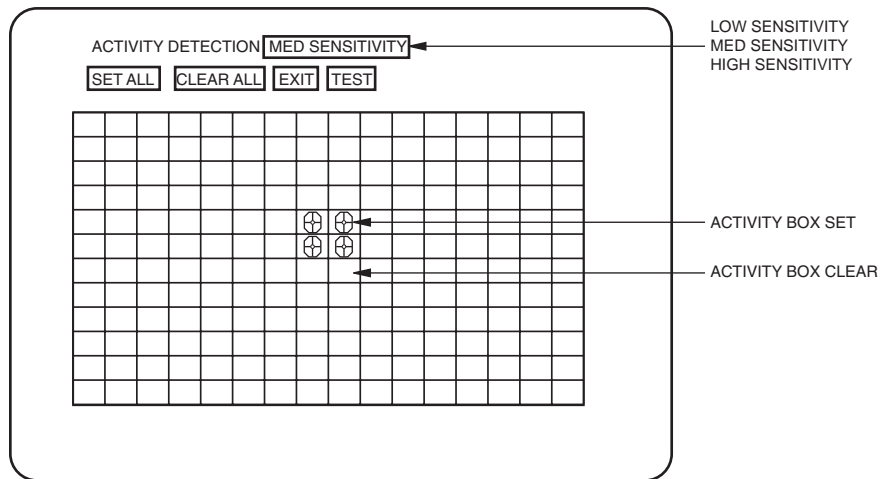

Figure 10. Activity Detection Mask

Activity detection continually monitors selected camera inputs for motion. When motion is detected, the multiplexer shows and records that camera(s) more frequently. Activity detection is most effective when only a few cameras are showing activity. As more cameras have activity, the frequency at which they are shown and recorded decreases. If all 16 cameras show activity, there will be virtually no increase.

The activity detection mask selects the portions of the camera's field of view the multiplexer will monitor for activity. The entire grid is active on default.

To program an activity detection mask for a camera:

1. Press the MAIN MONITOR key.
2. Select the camera.

Addressing by Multiplexer (Switch 7 OFF)

- a. On the number pad, enter the multiplexer's address number (1-16 if the keyboard is connected to a multiplexer; 1-8 if the keyboard is connected to a server), and then press the UNIT key.
- b. On the number pad, enter the camera's number, and then press and hold the CAM key until the Camera menu appears.

Addressing Consecutively (Switch 7 ON)

On the number pad, enter the camera's number, and then press and hold the CAM key until the Camera menu appears. Refer to Table A for camera numbers.

3. The currently selected menu item blinks. Use the joystick to highlight SET DETECTION MASK.
4. Press the OPEN key. The Activity Detection Mask appears. The currently selected menu item or activity box blinks.
5. Use the joystick to move between menu items and activity boxes on the screen.
6. Highlight the sensitivity menu item. Press the OPEN key to select the sensitivity. The higher the sensitivity, the less motion needed to detect activity.

7. Turn activity boxes on or off (the default is all are on).
 - **To turn on all boxes**, use the joystick to choose SET ALL. Press the OPEN key. All boxes contain a symbol (as shown in Figure 10). The multiplexer monitors activity in those boxes.
 - **To turn off all boxes**, use the joystick to choose CLEAR ALL. Press the OPEN key. All boxes are blank.
 - **To turn on or off an individual box**, use the joystick to select the box. Press the OPEN key to toggle the box on or off.

Turn off boxes where you want activity ignored, such as blowing trees, highways, computer monitors, fluorescent lighting, and non-problem areas. An example of a non-problem area would be a camera focused on a bank vault entrance but ignoring tellers working nearby.
8. To test activity detection, highlight TEST and press the OPEN key.

Create motion in front of the camera. Small black and white dashes flash where activity is detected.

To exit test mode, press the OPEN key to return to the mask.
9. If you did not like what you saw in test mode, change the mask and retest.
10. When you finish defining the activity detection mask, go to EXIT. Press the OPEN or CLOSE key to exit programming mode.
11. If necessary, repeat steps 1-10 to program the activity detection mask for other cameras.

SEQUENCE SETUP (SEQ KEY)

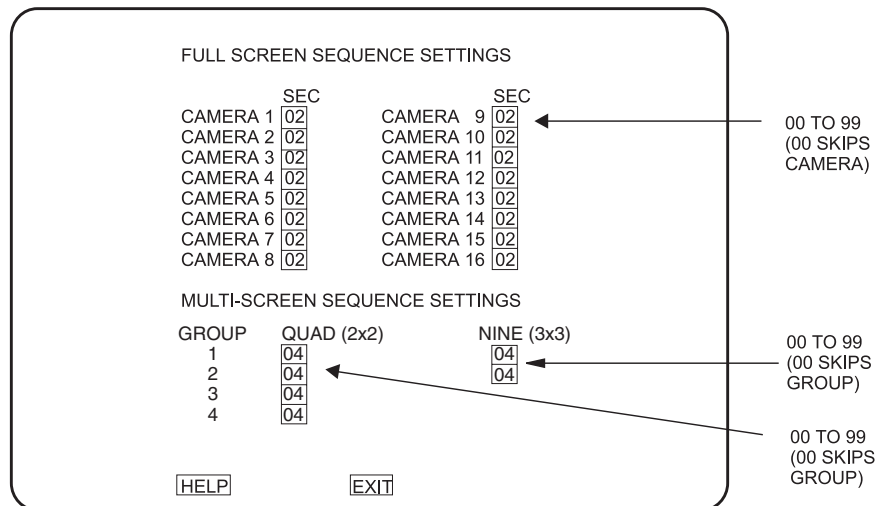

Figure 11. Camera Sequencing Menu

Sequencing can be programmed in full-screen, four-camera, and nine-camera displays. The cameras will not sequence when you are zooming. The LEDs above the camera buttons on the multiplexer light to indicate which cameras are being displayed.

To program camera sequencing:

1. Press the MAIN MONITOR key.
2. Use the number pad to enter the multiplexer's address (1-16 if the keyboard is connected to a multiplexer; 1-8 if the keyboard is connected to a server), and then press the UNIT key.

3. Press the SEQ key for about three seconds.
4. Type the password (3916), if requested. Enter it by pressing each number key followed each time by the CAM key. The Sequence menu appears. The currently selected menu item blinks.
5. Use the joystick to move among items on the screen. When the menu item you desire is highlighted (blinking), press the OPEN key to cycle through the options to select the one you want.
6. Press the OPEN key to exit programming mode.

When HELP is highlighted, you can press the OPEN key to display a help screen that tells you which keys to press to configure specific options.

HELP MENU

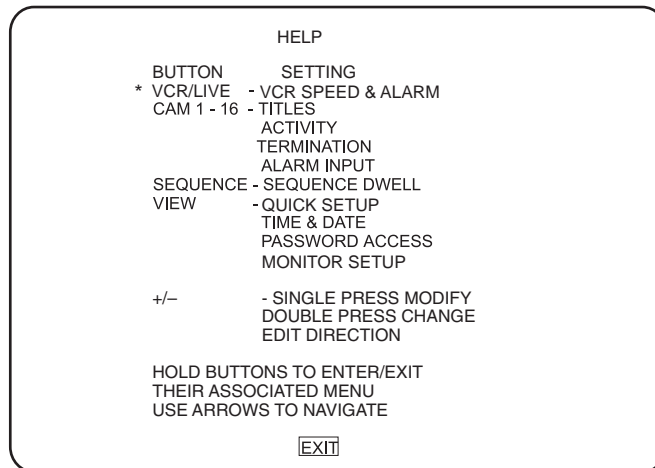

* SIMPLEX MULTIPLEXERS SHOW "DISP/REC".
PRESS THE "LIVE/VCR" KEY ON THE KEYBOARD.

Figure 12. Help Menu

Access the Help menu from any other menu.

1. Use the joystick in any menu to highlight HELP.
2. Press the OPEN key. The Help menu appears.

ALARM LOG

The alarm log cannot be accessed through the keyboard—only through the multiplexer. Refer to the multiplexer manual for instructions.





MULTIPLE CAMERA DISPLAY SETUP

You can use the keyboard to configure multiple camera display formats. The LEDs above the camera buttons on the multiplexer light to indicate which cameras are being displayed.

PROGRAMMING THE PICTURE-IN-PICTURE DISPLAY ()

You can program the on-screen location and size of the picture-in-picture (PIP) display. PIP is unavailable in **duplex** VCR playback and in **simplex** record mode.



To program the PIP display:

1. Press the MAIN MONITOR key.
2. Use the number pad to enter the multiplexer's address (1-16 if the keyboard is connected to a multiplexer; 1-8 if the keyboard is connected to a server), and then press the UNIT key.
3. Press the  key.
4. Press the  key for about three seconds until the message PROGRAM PIP SIZE appears.
5. Use the joystick to increase or decrease the PIP display size.
6. Press the  key for about three seconds until the message PROGRAM PIP POSITION appears.
7. Use the joystick to move the PIP display location.
8. Press and hold the  key to exit the PIP programming menu.

PROGRAMMING THE 4-CAMERA DISPLAY ()

You can program four groups of four cameras each. Each of the four groups can be programmed to include any four cameras.  is unavailable in **simplex** record mode.

To program the four-camera displays:

1. Press the MAIN MONITOR key.
2. Use the number pad to enter the multiplexer's address (1-16 if the keyboard is connected to a multiplexer; 1-8 if the keyboard is connected to a server), and then press the UNIT key.
3. Press the  key to call up a four-camera display. If necessary, press the  key again to advance to the four-camera group you wish to configure.
4. Press the  key for about three seconds. A bar appears in the first camera location of the four-camera display, indicating that you are in programming mode.
5. Use the joystick to move to each camera location in the four-camera display.
6. When the camera location you desire is highlighted, choose the new camera by pressing the number key for the desired camera and then pressing the CAM key.
7. To exit programming mode, use the joystick to move the bar off the screen.
8. If necessary, repeat steps 1-7 to program another group.

PROGRAMMING THE 9-CAMERA DISPLAY (3x3)

You can program two groups of nine cameras each. Both groups can be programmed to include any nine cameras. 3x3 is unavailable in **simplex** record mode.

To program the nine-camera displays:

1. Press the MAIN MONITOR key.
2. Use the number pad to enter the multiplexer's address (1-16 if the keyboard is connected to a multiplexer; 1-8 if the keyboard is connected to a server), and then press the UNIT key.
3. Press the 3x3 to call up a nine-camera display. If necessary, press the 3x3 again to advance to the other nine-camera group.
4. Press the 3x3 for about three seconds. A bar appears in the first camera location of the nine-camera display, indicating that you are in programming mode.
5. Use the joystick to move to each camera location in the nine-camera display.
6. When the camera location you desire is highlighted, choose the new camera by pressing the number key for the desired camera and then pressing the CAM key.
7. To exit programming mode, use the joystick to move the bar off the screen.
8. If necessary, repeat steps 1-7 to program another group.

PROGRAMMING THE 16-CAMERA DISPLAY (4x4)

4x4 is unavailable in **simplex** record mode.

To program the 16-camera display:

1. Press the MAIN MONITOR key.
2. Use the number pad to enter the multiplexer's address (1-16 if the keyboard is connected to a multiplexer; 1-8 if the keyboard is connected to a server), and then press the UNIT key.
3. Press the 4x4 key to call up the 16-camera display.
4. Press the 4x4 key for about three seconds. A bar appears in the first camera location of the 16-camera display, indicating that you are in programming mode.
5. Use the joystick to move to each camera location in the 16-camera display.
6. When the camera location you desire is highlighted, choose the new camera by pressing the number key for the desired camera and then pressing the CAM key.
7. To exit programming mode, use the joystick to move the bar off the screen.

PROGRAMMING MENU DEFAULTS

Table D. Programming Menu Defaults

Menu	Item	Default
System Setup	Time Display Title Display Normal Record Speed Alarm Record Speed Main Monitor Video (Duplex Only) Main Monitor Display Reset All Video Terminations To Reset All Alarm Inputs to Normally Reset All Seq Dwell Rates To Reset Activity Detection All Ch To	On On 2/6/8 Hr (NTSC/EIA) 3 Hr (PAL/CCIR) 2/6/8 Hr (NTSC/EIA) 3 Hr (PAL/CCIR) Composite High Resolution 75 Ohm Opened 02 Enabled
Advanced System Setup	Date Format Password System Password Front Panel Control Main Monitor Display Responds To Spot Monitor Display Responds To Aux Monitor Display (Duplex Only) Responds To (Duplex Only) Camera Types Unit ID Comm. Type Relay Output	MM-DD-YY (NTSC/EIA) DD-MM-YY (PAL/CCIR) Disabled 3916 Enabled None Sequence Alarms Blank Activity All Color (All B/W for monochrome) 001 Master (KBD-T/D) (Simplex) Slave (Duplex) Alarm
Record Setup	Normal Rec. Speed Alarm Rec. Speed VCR Type VCR Video Format VCR Switch Pulse Record Alarms Alarm Record Time Playback Format	2/6/8 Hr (NTSC/EIA) 3 Hr (PAL/CCIR) 2/6/8 Hr (NTSC/EIA) 3 Hr (PAL/CCIR) Universal Composite Disabled As A Priority Alarm Duration Pelco
Custom VCR Setup	Normal Record Speed Normal Switch Interval Alarm Record Speed Alarm Switch Speed	2/6/8 Hr (NTSC/EIA) 3 Hr (PAL/CCIR) 003 2/6/8 Hr (NTSC/EIA) 3 Hr (PAL/CCIR) 003
Camera	Title Video Input Termination Alarm Input Normally Coaxitron® Format Activity Detection	Camera Number 75 Ohm Open Extended (Simplex) Off (Duplex) Enabled
Activity Detection	Sensitivity Activity Boxes	Med Set All
Sequence	Individual Camera Dwell Time Quad (2x2) Dwell Time Nine (3x3) Dwell Time	02 04 04

PROGRAMMING A PRESET

NOTE: DIP switch number 8 must be ON for programming.

NOTE: The LEDs above the camera buttons on the multiplexer light to show which cameras are being displayed.

1. Press the MAIN or SPOT MONITOR key. The green LED over the MAIN or SPOT key lights.

When using the MAIN MONITOR, the SPOT MONITOR DISPLAY menu item in the Advanced System Setup menu **must be** set to TRACK MAIN (refer to the *Advanced System Setup* section).

2. Select the camera.

Addressing by Multiplexer (Switch 7 OFF)

- a. On the number pad, enter the multiplexer's address number (1-16 if the keyboard is connected to a multiplexer; 1-8 if the keyboard is connected to a server), and then press the UNIT key. The LED displays the address.
- b. On the number pad, enter the camera's number (1-16), and then press the CAM key.

Addressing Consecutively (Switch 7 ON)

On the number pad, enter the camera's number, and then press the CAM key. Refer to Table A for camera numbers.

3. Position the camera.
4. On the number pad, enter the preset's number, and then hold down the PRESET key for five seconds.

PROGRAMMING A PATTERN

NOTE: Refer to your dome or pan and tilt system manual for information on the number of available patterns and pattern durations.

1. Press the MAIN or SPOT MONITOR key. The green LED over the MAIN or SPOT key lights.

When using the MAIN MONITOR, the SPOT MONITOR DISPLAY menu item in the Advanced System Setup menu **must be** set to TRACK MAIN (refer to the *Advanced System Setup* section).

2. Select the camera.

Addressing by Multiplexer (Switch 7 OFF)

- a. On the number pad, enter the multiplexer's address number (1-16 if the keyboard is connected to a multiplexer; 1-8 if the keyboard is connected to a server), and then press the UNIT key. The LED displays the address.
- b. On the number pad, enter the camera's number (1-16), and then press the CAM key.

Addressing Consecutively (Switch 7 ON)

On the number pad, enter the camera's number, and then press the CAM key. Refer to Table A for camera numbers.

3. On the number pad, press a number key for the pattern number. Example: If you are programming pattern 1 press the number 1 key. Then hold down the PATTERN key until the message PROGRAMMING PATTERN appears on the screen.
4. Move the camera through the pattern.
5. To stop programming the pattern, repress the number key for the pattern followed by the PATTERN key. Example: Press number 1 and then the PATTERN key if you are programming pattern 1. The message PROGRAMMING PATTERN disappears.

OPERATION

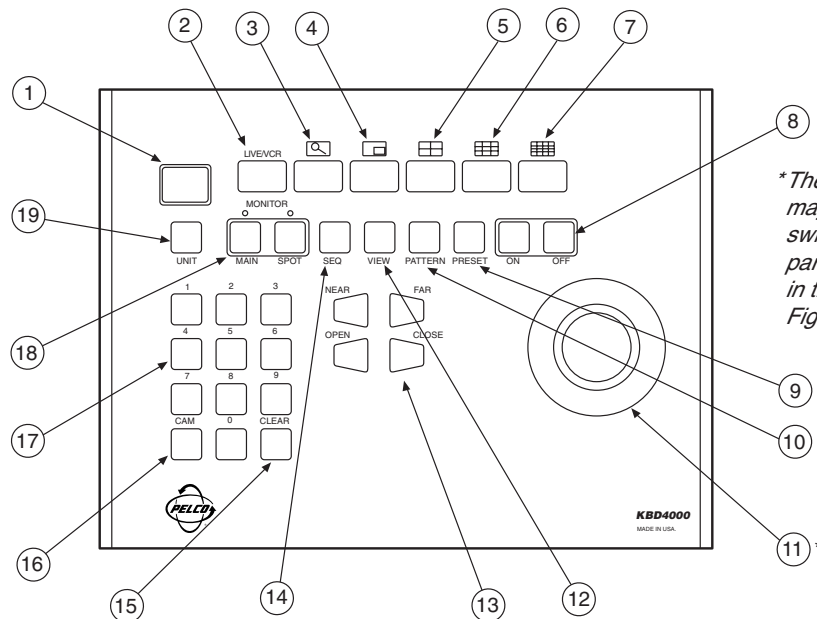

For complete instructions on how to use the keys, refer to Table E, Operation Guide.

1. **LED DISPLAY** Displays the address of the multiplexer (from 1-16) with which the keyboard is communicating.
2. **LIVE/VCR KEY** Selects the source of video to display on the monitor(s). LIVE is live video from the cameras. VCR is recorded video that is played back from a VCR.

The simplex multiplexer must be in the record mode to record video. Check the main monitor screen to see that it indicates REC. Press the LIVE/VCR key to change modes.
3. **ZOOM KEY** Zooms in (2X or 4X) on the displayed camera. Use the joystick to control the zoom location.
4. **PIP KEY** Displays on the main monitor a picture-in-picture insert on top of the full-screen display.
5. **FOUR-CAMERA DISPLAY KEY** Press once to display a group of four cameras on the main monitor. Repeat pressing to display other groups.
6. **NINE-CAMERA DISPLAY KEY** Press once to display a group of nine cameras on the main monitor. Press again to display second group.
7. **16-CAMERA DISPLAY KEY** Press once to display all 16 cameras on the main monitor.
8. **AUXILIARY KEYS** Turn receiver auxiliary functions on and off.
9. **PRESET KEY** Sends a camera to a preset: Enter the preset number and then press this key. Also is used for programming presets.
10. **PATTERN KEY** Press to begin a pattern. Also is used to program a pattern.
11. **PTZ FUNCTION JOYSTICK** Variable-speed, vector-solving, bi-directional joystick for pan/tilt control. Turbo pan* is achieved by full joystick deflection in either pan direction. Twisting head for zoom control. Controls PIP size and location also.
12. **VIEW KEY** Press and hold to enter program mode for multiplexer/multiplexer server. Press to view a multiplexed video signal going to a VCR.
13. **LENS CONTROL KEYS** Control camera lens iris and focus functions.
14. **SEQ KEY** Starts/stops a sequence.
15. **CLEAR KEY** Press to clear a numeric entry.
16. **CAM KEY** Selects a camera: Enter the camera number and then press this key.
17. **NUMBER PAD** Enter numbers.
18. **MONITOR KEYS** Select the main or spot monitor for viewing individual cameras. A green LED above each key indicates which monitor is selected.
19. **UNIT KEY** Selects the multiplexer with which the keyboard communicates: Enter the address of the multiplexer (1-16) and then press this key.

Figure 13. KBD4000 Keyboard Definitions

Table E. Operation Guide

Refer to "Functions" in the Index for an alphabetical list of the operations described in Table E.

NOTE: *References to switch 7 in this table refer to the switch behind the panel on the back of the keyboard. There are two modes for addressing cameras: by addressing all cameras consecutively from 1-256 (switch 7 ON, refer to Table A) or by addressing cameras in groups of 9 or 16 according to the multiplexer to which they are attached (switch 7 OFF); for example, multiplexer 1, cameras 1-9 or 1-16; multiplexer 2, cameras 1-9 or 1-16, etc.*

OPERATION	KEYBOARD COMMAND	RESULT
<p>Call a camera to the main monitor.</p>	<ol style="list-style-type: none"> 1. Press the MAIN MONITOR key. The green LED over the MAIN key lights. 2. Select the camera. <p>Addressing by Multiplexer (Switch 7 OFF)</p> <ol style="list-style-type: none"> a. On the number pad, press the multiplexer's address number (1-16 if the keyboard is connected to the multiplexer; 1-8 if connected to a server), and then press the UNIT key. The LED displays the address. b. On the number pad, press the camera number (1-16), and then press the CAM key. <p>Addressing Consecutively (Switch 7 ON)</p> <p>On the number pad, press the camera number, and then press the CAM key. Refer to Table A for camera numbers.</p> 3. Press the LIVE/VCR key to select the operation mode. 	<p>Displays the camera on the main monitor.</p> <p>Stops a sequence if one is in progress.</p>
<p>Call a camera to the spot monitor.</p>	<ol style="list-style-type: none"> 1. Press the SPOT MONITOR key. The green LED over the SPOT key lights. 2. Select the camera. (You cannot select the camera when TRACK MAIN is set in Advanced Setup.) <p>Addressing by Multiplexer (Switch 7 OFF)</p> <ol style="list-style-type: none"> a. On the number pad, press the multiplexer's address number (1-16 if the keyboard is connected to the multiplexer; 1-8 if connected to a server), and then press the UNIT key. The LED displays the address. b. On the number pad, press the camera number (1-16), and then press the CAM key. <p>Addressing Consecutively (Switch 7 ON)</p> <p>On the number pad, press the camera number, and then press the CAM key. Refer to Table A for camera numbers.</p> 	<p>Displays the camera on the spot monitor.</p>
<p>Set main tracking.</p>	<ol style="list-style-type: none"> 1. Go to the Advanced System Setup menu. 2. Move the joystick so the cursor highlights SPOT MONITOR DISPLAY items. 3. Press the OPEN key until TRACK MAIN is displayed. 4. Exit the Advanced System Setup menu. 	<p>Spot monitor follows the camera switching that occurs on the main monitor in single-screen mode. In multi-screen mode, the spot monitor switches to camera 1.</p> <p>Allows only PTZ control while in main monitor mode. Press the SPOT key to have presets and patterns while in this mode.</p>

(Continued on next page)

Table E. Operation Guide (Continued)

OPERATION	KEYBOARD COMMAND	RESULT
Exit main tracking.	<ol style="list-style-type: none"> 1. Go to the Advanced System Setup menu. 2. Move the joystick so the cursor highlights SPOT MONITOR DISPLAY items. 3. Press the OPEN key until SEQUENCE or BLANK is displayed. 4. Exit the Advanced System Setup menu. 	Exits main tracking mode.
Call a group of cameras to the main monitor.	<ol style="list-style-type: none"> 1. Press the MAIN MONITOR key. The green LED over the MAIN key lights. 2. On the number pad, press the multiplexer's address number (1-16 if the keyboard is connected to a multiplexer; 1-8 if connected to a server), and then press the UNIT key. The LED displays the address. 3. Press the key below the 4, 9, or 16 icon. 4. Repeatedly press the key until the correct group is displayed (4 or 9 only). 5. Press the LIVE/VCR key to select the operating mode. 	Displays the group of cameras on the main monitor.
Display a picture-in-picture (PIP) insert on the main monitor.	<ol style="list-style-type: none"> 1. Press the MAIN MONITOR key. The green LED over the MAIN key lights. 2. Select the camera you want displayed full size. <ul style="list-style-type: none"> Addressing by Multiplexer (Switch 7 OFF) <ol style="list-style-type: none"> a. On the number pad, press the multiplexer's address number (1-16 if the keyboard is connected to the multiplexer; 1-8 if connected to a server), and then press the UNIT key. The LED displays the address. b. On the number pad, press the camera number (1-16), and then press the CAM key. Addressing Consecutively (Switch 7 ON) <p>On the number pad, press the camera number, and then press the CAM key. Refer to Table A for camera numbers.</p> 3. Ensure the main monitor displays live video. If not live, press the LIVE/VCR key. 4. Press the PIP icon key. 5. On the number pad, press the number of the camera you want to display in the insert. Then press the CAM key. (Note: Both cameras must be connected to the same multiplexer.) 6. To change the insert display, press the number of the camera, and then press the CAM key. 7. To exit, press the PIP icon key. 	<p>The full-size view appears on the main monitor with PIP insert.</p> <p>NOTE: You must exit PIP mode to change the camera shown in full-screen view.</p>

(Continued on next page)

Table E. Operation Guide (Continued)

OPERATION	KEYBOARD COMMAND	RESULT
<p>Zoom on a camera on the main monitor.</p>	<ol style="list-style-type: none"> 1. Press the MAIN MONITOR key. The green LED over the MAIN key lights. 2. Select the camera. <p>Addressing by Multiplexer (Switch 7 OFF)</p> <ol style="list-style-type: none"> a. On the number pad, press the multiplexer's address number (1-16 if the keyboard is connected to the multiplexer; 1-8 if connected to a server), and then press the UNIT key. The LED displays the address. b. On the number pad, press the camera number (1-16), and then press the CAM key. <p>Addressing Consecutively (Switch 7 ON)</p> <p>On the number pad, press the camera number, and then press the CAM key. Refer to Table A for camera numbers.</p> 3. Press the LIVE/VCR key to select the operating mode. 4. Press the key below the zoom icon. Zoom will be 2X. Press again for 4X. 5. Use the joystick to control the zoom location. 6. To exit, press the zoom icon key or the number of the camera, and then press the CAM key. 	<p>Displays a 2X or 4X zoom of the camera selected on the main monitor.</p> <p>Stops a sequence if one is in progress.</p>
<p>Run a sequence of cameras from one multiplexer on the main monitor.</p>	<ol style="list-style-type: none"> 1. Press the MAIN MONITOR key. The green LED over the MAIN key lights. 2. Select a camera on the multiplexer you want to sequence. <p>Addressing by Multiplexer (Switch 7 OFF)</p> <ol style="list-style-type: none"> a. On the number pad, press the multiplexer's address number (1-16 if the keyboard is connected to the multiplexer; 1-8 if connected to a server), and then press the UNIT key. The LED displays the address. b. On the number pad, press the camera number (1-16), and then press the CAM key. <p>Addressing Consecutively (Switch 7 ON)</p> <p>On the number pad, press the camera number, and then press the CAM key. Refer to Table A for camera numbers.</p> 3. Press the LIVE/VCR key to select the operating mode. 4. To sequence individual cameras, go to step 5. To sequence groups of cameras, press the key below the 4- or 9-screen icon, and then go to step 5. 5. Press the SEQ key. 	<p>Starts the programmed sequence of individual cameras or groups of cameras on the main monitor.</p>

(Continued on next page)

Table E. Operation Guide (Continued)

OPERATION	KEYBOARD COMMAND	RESULT
<p>Run a sequence of cameras from one multiplexer on the spot monitor. (SPOT MONITOR DISPLAY in the Advanced System Setup menu must be in SEQUENCE.)</p>	<ol style="list-style-type: none"> 1. Press the SPOT MONITOR key. The green LED over the SPOT key lights. 2. Select a camera on the multiplexer you want to sequence. <p>Addressing by Multiplexer (Switch 7 OFF)</p> <ol style="list-style-type: none"> a. On the number pad, press the multiplexer's address number (1-16 if the keyboard is connected to the multiplexer; 1-8 if connected to a server), and then press the UNIT key. The LED displays the address. b. On the number pad, press the camera number (1-16), and then press the CAM key. <p>Addressing Consecutively (Switch 7 ON)</p> On the number pad, press the camera number, and then press the CAM key. Refer to Table A for camera numbers. 3. Press the SEQ key. 	<p>Starts the sequence of individual cameras on the spot monitor.</p>
<p>Stop a sequence of cameras on a multiplexer.</p>	<ol style="list-style-type: none"> 1. Press the MAIN or SPOT MONITOR key. 2. On the number pad, press the multiplexer's address number (1-16 if the keyboard is connected to the multiplexer; 1-8 if connected to a server), and then press the UNIT key. The LED displays the address. 3. Press the SEQ key. 	<p>Stops the sequence. The monitor displays video from the camera on which sequence stops.</p>
<p>Sequence multiplexers connected to a server.</p>	<ol style="list-style-type: none"> 1. Select the desired multi-camera display. 2. Press and hold the multi-camera display key to enter multi-screen programming mode. A bar appears in the first camera location. 3. Use the joystick to move the on-screen bar to the desired camera location for sequencing, and press the SEQ key to initiate the sequencing of all active cameras. 	<p>The sequence will run until the SEQ key is pressed or until another camera or multi-screen display is selected.</p>
<p>Sequence multiplexers connected to a server and sequence cameras on a multiplexer(s).</p>	<p>Hold down the SEQ key for about three seconds.</p>	<p>Starts sequencing the multiplexers in numerical order, displaying the main monitor first, and then the spot monitor. Monitors to be displayed are selected in the Set Sequence submenu of the server's Monitor menu. Sequencing appears on the monitor affiliated with the keyboard; for example, if the keyboard is set for address 1, the sequence appears on monitor 1.</p>

(Continued on next page)

Table E. Operation Guide (Continued)

OPERATION	KEYBOARD COMMAND	RESULT
Sequence multiple cameras in one location of a 4-, 9-, or 16-camera display.	<ol style="list-style-type: none"> 1. Follow the steps under “Run a sequence of cameras from one multiplexer on the main monitor” or “Run a sequence of cameras from one multiplexer on the spot monitor” to start sequencing the cameras on the main and spot monitors of individual multiplexers you want to sequence. 2. Hold down the SEQ key for about three seconds to start sequencing the multiplexers. 	Starts sequencing the multiplexers in numerical order, displaying the main monitor first, and then the spot monitor. Monitors to be displayed are selected in the Set Sequence submenu of the server’s Monitor menu. As each monitor is displayed, it sequences. Sequencing appears on the monitor affiliated with the keyboard; for example, if the keyboard is set for address 1, the sequence appears on monitor 1.
Sequence the picture-in-picture (PIP) display.	<ol style="list-style-type: none"> 1. Press the  key. 2. Press the SEQ key. 	Sequences all active cameras in the PIP display.
Stop a sequence of multiplexers.	Move the joystick or select any camera.	Sequence stops.
Call a camera or run a sequence of cameras on the auxiliary monitor (duplex multiplexer only).	Program the monitor in the Advanced System Setup menu.	Monitor responds to programming instructions.
Call a preset.	<ol style="list-style-type: none"> 1. Press the MAIN or SPOT MONITOR key. The green LED over the MAIN or SPOT key lights. When using the MAIN MONITOR, the SPOT MONITOR DISPLAY menu item in the Advanced System Setup menu must be set to TRACK MAIN (refer to the <i>Advanced System Setup</i> section). 2. Select the camera. <p>Addressing by Multiplexer (Switch 7 OFF)</p> <ol style="list-style-type: none"> a. On the number pad, press the multiplexer’s address number (1-16 if the keyboard is connected to the multiplexer; 1-8 if connected to a server), and then press the UNIT key. The LED displays the address. b. On the number pad, press the camera number (1-16), and then press the CAM key. <p>Addressing Consecutively (Switch 7 ON)</p> On the number pad, press the camera number, and then press the CAM key. Refer to Table A for camera numbers. 3. On the number pad, press the number of the preset, and then press the PRESET key. (Note: When calling preset 95 on Esprit and Spectra systems, hold the PRESET key until the menu appears.) 	Moves the camera to the preset location.

(Continued on next page)

Table E. Operation Guide (Continued)

OPERATION	KEYBOARD COMMAND	RESULT
Start auto scan with 15-bit receiver.	<ol style="list-style-type: none"> 1. Press the SPOT MONITOR key. The green LED over the SPOT key lights. 2. Select the camera. Addressing by Multiplexer (Switch 7 OFF) <ol style="list-style-type: none"> a. On the number pad, press the multiplexer's address number (1-16 if the keyboard is connected to the multiplexer; 1-8 if connected to a server), and then press the UNIT key. The LED displays the address. b. On the number pad, press the camera number (1-16), and then press the CAM key. Addressing Consecutively (Switch 7 ON) On the number pad, press the camera number, and then press the CAM key. Refer to Table A for camera numbers. 3. On the number pad, press 97 and then the PRESET key. Starts auto scanning. 	Starts auto scanning.
Start random scan with 15-bit receiver.	With the system in auto scan, press 97 on the number keyboard, and then press the PRESET key.	Starts random scanning.
Start manual scan (or stop auto or random scan) with 15-bit receiver.	<ol style="list-style-type: none"> 1. Press the SPOT MONITOR key. The green LED over the SPOT key lights. 2. Select the camera. Addressing by Multiplexer (Switch 7 OFF) <ol style="list-style-type: none"> a. On the number pad, press the multiplexer's address number (1-16 if the keyboard is connected to the multiplexer; 1-8 if connected to a server), and then press the UNIT key. The LED displays the address. b. On the number pad, press the camera number (1-16), and then press the CAM key. Addressing Consecutively (Switch 7 ON) On the number pad, press the camera number, and then press the CAM key. Refer to Table A for camera numbers. 3. On the number pad, press 96 and then the PRESET key. 	Starts manual scanning. Stops auto or random scanning, if operating.
Begin a pattern.	<ol style="list-style-type: none"> 1. Press the MAIN or SPOT MONITOR key. The green LED over the MAIN or SPOT key lights. When using the MAIN MONITOR, the SPOT MONITOR DISPLAY menu item in the Advanced System Setup menu must be set to TRACK MAIN (refer to the <i>Advanced System Setup</i> section). 2. Select the camera. Addressing by Multiplexer (Switch 7 OFF) <ol style="list-style-type: none"> a. On the number pad, press the multiplexer's address number (1-16 if the keyboard is connected to the multiplexer; 1-8 if connected to a server), and then press the UNIT key. The LED displays the address. b. On the number pad, press the camera number (1-16), and then press the CAM key. Addressing Consecutively (Switch 7 ON) On the number pad, press the camera number, and then press the CAM key. Refer to Table A for camera numbers. 3. On the number pad, press 1 and then the PATTERN key. 4. To stop the pattern, move the joystick. 	The pattern operates until stopped.

(Continued on next page)

Table E. Operation Guide (Continued)

OPERATION	KEYBOARD COMMAND	RESULT
Turn an auxiliary function on or off.	<ol style="list-style-type: none"> 1. Press the SPOT MONITOR key. The green LED over the SPOT key lights. 2. Select the camera. <p>Addressing by Multiplexer (Switch 7 OFF)</p> <ol style="list-style-type: none"> a. On the number pad, press the multiplexer's address number (1-16 if the keyboard is connected to the multiplexer; 1-8 if connected to a server), and then press the UNIT key. The LED displays the address. b. On the number pad, press the camera number (1-16), and then press the CAM key. <p>Addressing Consecutively (Switch 7 ON)</p> On the number pad, press the camera number, and then press the CAM key. Refer to Table A for camera numbers. 3. On the number pad, press the number of the auxiliary you want to operate, and then press the AUX ON or OFF key. 	The auxiliary function operates.
Record a tape.	For the duplex multiplexer, recording is done automatically. For the simplex multiplexer, the multiplexer must be in record mode (DISPLAY/RECORD LED is on).	Records all cameras connected to the multiplexer. While the simplex multiplexer is in record mode, you can only see a full-screen view of one camera (or one camera at a time if sequencing) on the main monitor, but all active cameras are being recorded.
Play a tape.	<ol style="list-style-type: none"> 1. Press the MAIN MONITOR key. The green LED over the MAIN key lights. 2. On the number pad, press the multiplexer's address number (1-16 if the keyboard is connected to a multiplexer; 1-8 if connected to a server), and then press the UNIT key. The LED displays the address. 3. Press the LIVE/VCR key to put the multiplexer in playback mode. 4. Select the cameras to play back from one of the following: <ul style="list-style-type: none"> • For an individual camera, press the number of the camera and then the CAM key. If switch 7 is OFF, enter a camera number from 1-16. If ON, refer to Table A for camera numbers. • For multiple camera display, press the key below the 4-, 9-, or 16-camera icon. • For sequencing, select an individual or multiple camera display, and then press the SEQ button. 5. Turn on the VCR and press the PLAY button. 	Displays the recorded cameras in the selected format on the main monitor.

TROUBLESHOOTING

If you have difficulty operating your system, run through the following checklist to see if you can solve the problem.

1. Are the keyboard switches set properly?
2. Is the equipment wired properly?
3. Are the menu options in the multiplexer(s) and server set properly?
4. Is the multiplexer set to the correct mode for live video or tape playback?
5. Only the main monitor displays multiple-screen images. The spot monitor displays full-screen views only.
6. Patterns, presets, and auxiliaries operate with the spot monitor only. You must push the SPOT key, even if the spot monitor is set to track the main monitor. Tracking the main monitor applies to PTZ control only, not to patterns, presets, and auxiliaries.
7. Programming controls the auxiliary monitor (duplex multiplexer only). You cannot control it from the keyboard or from the multiplexer's front panel.
8. Tape playback can be done only on the main monitor (in VCR mode).
9. Moveable cameras must be Coaxitron compatible with the proper Coaxitron format selected in the multiplexer's Camera menu. If an improper format is selected, the camera will either not move or have sluggish control.
10. Moveable cameras can be operated with the joystick only if SPOT MONITOR is chosen or if the spot monitor is programmed to track the main monitor. The camera moves on the main monitor if the same camera is being shown on both the main and spot monitors.
11. Switch 7 on the keyboard determines how you call cameras.
 - If the switch is ON, all cameras are addressed consecutively. Do not count just the installed cameras. Count 16 camera inputs per multiplexer, even if a multiplexer has only nine inputs. The first input of multiplexer 1 is always camera 1; the first input of multiplexer 2 is always camera 17; the second input of multiplexer 3 is always camera 34.
 - If the switch is OFF, cameras are addressed in groups of 9 or 16 according to the multiplexer's address. Select a multiplexer (number 3 for example), then choose a camera (1-9 or 1-16).
12. Switch 4 on the keyboard determines the communication mode.
 - In polled communication mode (switch 4 OFF), if you have one multiplexer, it must be the master. If you have multiple multiplexers, one (any one) must be the master and all others slaves.
 - In non-polled communication mode (switch 4 ON), all multiplexers must be slaves. Refer to the multiplexer's Advanced System Setup menu.
13. If you have more than one multiplexer, each must have a unique address (multiplexer's Advanced System Setup menu).
14. If you have a server, the multiplexer's address must correspond to the server's input to which it is connected. For example, if the multiplexer goes to input 4 on the server, the multiplexer must be address 4.
15. If you have a server, each keyboard must have its own address.

16. If you have a server, each keyboard controls its corresponding monitors.
 - In SINGLE mode, keyboard 1 controls monitor 1, keyboard 2 controls monitor 2, etc.
 - In PAIRED mode, keyboard 1 controls monitor 1 (main) and monitor 2 (spot), and keyboard 3 controls monitor 3 (main) and monitor 4 (spot). In paired mode, keyboards 2 and 4 are not used.
17. If you have a server and cannot change between full-screen and multi-screen views on the main monitor, check the MAIN MONITOR CONTROL setting in the server's Monitor menu.
18. Inadvertently changing the UNIT ID (in the Advanced System Setup menu) at the keyboard can cause uncontrollable sequencing of unit ID numbers and loss of keyboard control. Do one of the following:
 - Press the down arrow button on the multiplexer. Sequencing should stop. Exit the menu, return to the Advanced System Setup menu, and change UNIT ID back to 001. Continue normal programming from the keyboard.
 - If the multiplexer is remotely located from the keyboard, wait until the numbers sequence to the correct multiplexer unit ID number and **immediately** move the joystick in any direction. Sequencing should stop. Continue normal programming from the keyboard.

SPECIFICATIONS

ELECTRICAL

Input Voltage: 12 VAC or ± 12 VDC
 Power Consumption: 5 watts

KEYBOARD COMMUNICATION

Keyboard Interface: RS-485 (25-foot flat cable supplied)
 Connector Type: RJ-45 8-pin modular (female)

MECHANICAL

Keyboard Keypad: Mechanical
 Joystick: Three-axis, vector solving, with twisting, return-to-center head
 Digital Display: Two red seven-segment LEDs
 Main/Spot Monitor Indicators: Two green LEDs

GENERAL

Ambient Operating Temperature: 20° to 120°F (-7° to 49°C)
 Humidity: 10% to 90%, non-condensing
 Dimensions: 9.50 in. W x 7.125 in. L x 2.25 in. H (24.13 x 18.10 x 5.72 cm)
 Weight: 2.5 lb (1.12 kg)
 Shipping Weight: 4 lb (1.81 kg)

(Design and product specifications subject to change without notice.)

INDEX

A

Activity detection 14
Activity detection mask setup 23
Address setting 9
Address switch setting 6, 8
Addressing by multiplexer 21, 23, 29
Addressing consecutively 21, 23, 29
Advanced system setup menu 15
Alarm handling 19
Alarm input 22
Alarm inputs 14
Alarm log 25
Aux monitor display 16

C

CAM key 21
Camera address mode switch setting 7, 8
Camera setup 21
Camera types 16
Coaxitron format 22
Coaxitron format settings 22
Comm type 17
Communication mode switch setting 6
Configure custom VCR 19
Controlling the multiplexer with the keyboard 11
Covert mode 21
Custom VCR setup menu 20

D

Date 13
Date format 15
Differences (simplex versus duplex) 5
Dwell rates 14

E

English 11

F

Fixed cameras setting 10, 22
Four-camera display programming 26
French 11
Front panel control 15
Functions
 call a preset 35
 call camera on auxiliary monitor 35
 call camera to main monitor 31
 call camera to spot monitor 31
 call group of cameras to main monitor 32
 display picture-in-picture 32
 exit main tracking 32
 play a tape 37
 record a tape 37
 run sequence on auxiliary monitor 35
 run sequence on main monitor 33
 run sequence on spot monitor 34
 sequence multiple cameras 35
 sequence multiplexers hooked to server 34
 sequence multiplexers hooked to server and cameras on multiplexer 34

 sequence pip display 35
 set main tracking 31
 start a pattern 36
 start auto scan (15-bit) 36
 start manual scan (15-bit) 36
 start random scan (15-bit) 36
 stop auto or random scan 36
 stop sequence of multiplexers 35
 turn auxiliary function on/off 37
 zoom camera on main monitor 33

G

German 11

H

Help menu 25

I

Installation (multiplexer mode) 6
Installation (multiplexer server mode) 8
Interval 20

K

Keyboard control of the multiplexer 11
Keyboard port connection 9
Keys
 cam 21
 live/VCR 18, 20
 number 21
 seq 24
 view 13, 15

L

Language 11
Live/VCR key 18, 20
Local keyboard port connection 9

M

Main monitor display 14, 15
Main monitor video 14
Master/slave 11
Master/slave designation 9
Menu defaults 28
Modes of operation 5, 6
Monitor display (main) 15
Monitor display (spot) 16
Moveable cameras setting 10, 22
Multiple camera display setup 26
Multiple multiplexers 9
Multiplexer mode installation 6
Multiplexer server mode installation 8

N

Nine-camera display programming 27
Normal/covert mode 21
Number key 21

O

Operating differences 5
Operating modes 5, 6

P

Paired mode 9
Password 11, 15
Pattern programming 29
Playback format 19
Polled/non-polled communication 9
Polled/non-polled communication mode 11, 17
Preset programming 29
Program mode switch setting 7
Programming a pattern 29
Programming a preset 29
Programming from the keyboard 12
Programming menu defaults 28
Programming mode switch setting 8
Programming the 16-camera display 27
Programming the 4-camera display 26
Programming the 9-camera display 27

R

Record setup menu 18
Record speeds 14, 18, 20
Relay output 17
Remote keyboard(s) port connection 9

S

SEQ key 24
Sequence setup 24
Set up multiple camera display 26
Sixteen-camera display programming 27
Slave/master 11
Slave/master designation 9
Spanish 11
Specifications 39
Spot monitor display 16
Switch settings 6
System setup menu 13

T

Termination 22
Time and date 13
Time display 13
Title display 13
Troubleshooting 38
Turbo mode switch setting 7

U

Unit ID 16
Unused switch setting 7, 8

V

VCR switch pulse 19
VCR type 18
VCR video format 18
Video termination 22
Video terminations 14
View key 13, 15

WARRANTY AND RETURN INFORMATION

WARRANTY

Pelco will repair or replace, without charge, any merchandise proved defective in material or workmanship for a period of one year after the date of shipment. Exceptions to this warranty are as noted below:

- Five years on Pelco manufactured cameras (CC3500/CC3600/CC3700 and MC3500/MC3600 Series); two years on all other cameras.
- Three years on Genex® Series (multiplexers, server, and keyboard).
- Two years on all standard motorized or fixed focal length lenses.
- Two years on Legacy®, Camclosure® Camera Systems, CM6700/CM6800/CM8500/CM9500/CM9740/CM9760 Matrix, DF5 and DF8 Series Fixed Dome products.
- Two years on Spectra®, Esprit®, and PS20 Scanners, including when used in continuous motion applications.
- Two years on Esprit and WW5700 series window wiper (excluding wiper blades).
- Eighteen months on DX Series digital video recorders.
- One year (except video heads) on video cassette recorders (VCRs). Video heads will be covered for a period of six months.
- Six months on all pan and tilts, scanners or preset lenses used in continuous motion applications (that is, preset scan, tour and auto scan modes).

Pelco will warrant all replacement parts and repairs for 90 days from the date of Pelco shipment. All goods requiring warranty repair shall be sent freight prepaid to Pelco, Clovis, California. Repairs made necessary by reason of misuse, alteration, normal wear, or accident are not covered under this warranty.

Pelco assumes no risk and shall be subject to no liability for damages or loss resulting from the specific use or application made of the Products. Pelco's liability for any claim, whether based on breach of contract, negligence, infringement of any rights of any party or product liability, relating to the Products shall not exceed the price paid by the Dealer to Pelco for such Products. In no event will Pelco be liable for any special, incidental or consequential damages (including loss of use, loss of profit and claims of third parties) however caused, whether by the negligence of Pelco or otherwise.

The above warranty provides the Dealer with specific legal rights. The Dealer may also have additional rights, which are subject to variation from state to state.

If a warranty repair is required, the Dealer must contact Pelco at (800) 289-9100 or (559) 292-1981 to obtain a Repair Authorization number (RA), and provide the following information:

1. Model and serial number
2. Date of shipment, P.O. number, Sales Order number, or Pelco invoice number
3. Details of the defect or problem

If there is a dispute regarding the warranty of a product which does not fall under the warranty conditions stated above, please include a written explanation with the product when returned.

Method of return shipment shall be the same or equal to the method by which the item was received by Pelco.

RETURNS

In order to expedite parts returned to the factory for repair or credit, please call the factory at (800) 289-9100 or (559) 292-1981 to obtain an authorization number (CA number if returned for credit, and RA number if returned for repair).

All merchandise returned for credit may be subject to a 20% restocking and refurbishing charge.

Goods returned for repair or credit should be clearly identified with the assigned CA or RA number and freight should be prepaid. Ship to the appropriate address below.

If you are located within the continental U.S., Alaska, Hawaii or Puerto Rico:
 Service Department
 Pelco
 3500 Pelco Way
 Clovis, CA 93612-5699

If you are located outside the continental U.S., Alaska, Hawaii or Puerto Rico:

<p>Intermediate Consignee American Overseas Air Freight 320 Beach Road Burlingame, CA 94010 USA</p>	<p>Ultimate Consignee Pelco 3500 Pelco Way Clovis, CA 93612-5699 USA</p>
--	---

REVISION HISTORY

Manual #	Date	Comments
C1921M	5/98	Preliminary version released for beta evaluation.
	7/98	Original version.
C1921M-A	12/98	Added Sections 5.0 through 5.4. Added note to section 3.1. Added operations to Table C.
C1921M-B	7/99	Added use of keyboard with simplex multiplexers. Revised manual to new format.
C1921M-C	9/99	Added polled/non-polled communication. Added steps 1 and 2 to programming menus. Added tip about how to switch between menus. Added information about camera types. Added information about TRACK MAIN feature with presets and patterns.
C1921M-D	9/00	Added information on language option. Reorganized manual with index.
C1921M-E	6/02	Revised graphics to reflect new joystick. Added material about powering up keyboard.
C1921M-F	9/03	Moved Regulatory Notices section and changed power specification.
C1921M-G	1/04	Revised per ECO #03-9291, software upgrade to increase the number of programmable patterns.

® Pelco, the Pelco logo, Spectra, Genex, Legacy, Esprit, Camclosure, and Coaxitron are registered trademarks of Pelco. © Copyright 2002, Pelco. All rights reserved.